



## Advanced line of miniature Asian style of photoelectric sensors

- 40-300 mm background suppression
- 0.7 m proximity, 150 mm with narrow beam
- 4 m polarized retroreflective
- 30 m LASER through beam
- Standard 3-wire output configuration



SENSORS

### APPLICATIONS

- Processing and Packaging machinery
- Electronics assembling



S3Z		
Through beam		0...20 m 0...30 m (class 1 LASER)
Polarized retroreflective		0.05...4 m 0,3...10 m (class 1 LASER)
Retroreflective for transparent (on R2 reflector)		0...2 m
Diffuse proximity		0...700 mm 50...150 mm (narrow beam)
Background suppression		50...300 mm 40...300 mm (class 1 LASER)
Power supply	Vdc	10...30 V
	Vac	
	Vac/dc	
Output	PNP	▪
	NPN	▪
	NPN/PNP	
	relay	
	other	
Connection	cable	▪
	connector	▪
	pig-tail	
Approximate dimensions (mm)		11x31x19
Housing material		PC/PBT
Mechanical protection		IP67

## GENERAL DATA

Power supply	10 ... 30 Vdc
Output current	≤100 mA
Saturation voltage	≤ 2V (LED Mod.), ≤ 1,5V (LASER Mod.)
Consumption (output current excluded)	35 mA max.
Response time	1 ms (LED Mod.), 250 μs (LASER Mod.)
Switching frequency	500 Hz (LED Mod.), 2 kHz (LASER Mod.)
Light emission	RED LED 665 nm, INFRARED LED 870 nm (S3Z-...-C11/FG01), RED LASER class 1 EN 60825-1
Setting	Sensitivity trimmer, L/D selection trimmer (LASER Mod.)
Indicators	Yellow OUTPUT LED, Green STABILITY LED, Green POWER ON LED (through beam emitter)
Outputs	PNP or NPN, LIGHT mode (N.O.), DARK mode (N.C.)
Protection devices	Reverse polarity protection, Overload and short-circuit protection
Operating temperature	-25 ... +55°c
Storage temperature	-25 ... +70°c
Housing material	Body PBT / indicators cover PC
Lens material	PMMA, PC
Insulating strength	500 Vac 1 min., between electronics and housing
Insulating resistance	>20 MΩ 500 Vdc, between electronics and housing
Ambient light rejection	according to EN 60947-5-2
Vibration	0.5 mm amplitude, 10 ... 55 Hz frequency, for every axis (EN60068-2-6)
Shock resistance	11 ms (30 G) 6 shock for every axis (EN60068-2-27)
Mechanical protection	IP67
Connections	2 m cable, Ø 3.5 mm, 4-pole M8 connector
Weight	10 g (Connector Mod.), 50 g (Cable Mod.)

## DIMENSIONS

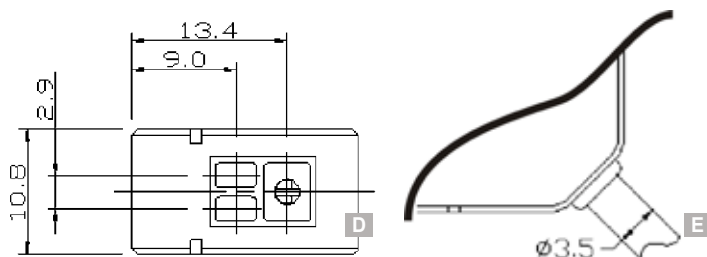
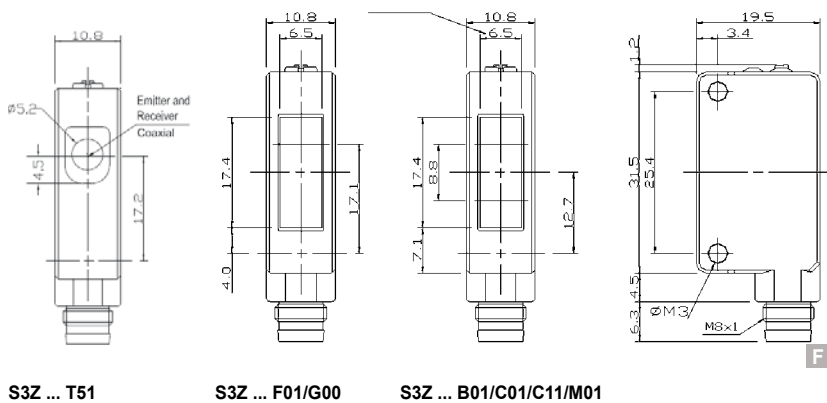

## CONNECTIONS

### S3Z ... B01/C01/C11/M01/T51

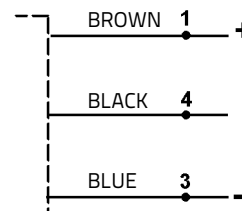

### S3Z ... G00

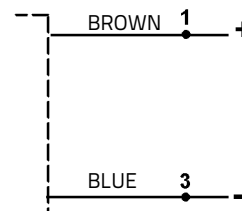

### M8 CONNECTOR

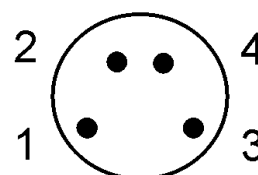

RED LED MODELS					
OPTIC FUNCTION	OPERATING DISTANCE	OUTPUT	CONNECTION	MODEL	ORDER No.
Polarized retroreflective	6 m (on R5)	PNP - LIGHT	2 m cable	S3Z-PR-2-B01-PL	95B010081
			M8 connector	S3Z-PR-5-B01-PL	95B010091
		PNP - DARK	2 m cable	S3Z-PR-2-B01-PD	95B010101
			M8 connector	S3Z-PR-5-B01-PD	95B010111
		NPN - LIGHT	2 m cable	S3Z-PR-2-B01-NL	95B010241
			M8 connector	S3Z-PR-5-B01-NL	95B010251
NPN - DARK	2 m cable	S3Z-PR-2-B01-ND	95B010261		
	M8 connector	S3Z-PR-5-B01-ND	95B010271		
Polarized retroreflective for transparent	0...2 m (on R2)	PNP - DARK	2 m cable	S3Z-PR-2-T51-PD	95B010380
			M8 connector	S3Z-PR-5-T51-PD	95B010360
		NPN - DARK	2 m cable	S3Z-PR-2-T51-ND	95B010390
			M8 connector	S3Z-PR-5-T51-ND	95B010370
Short diffuse proximity	50...150 mm	PNP - LIGHT	2 m cable	S3Z-PR-2-C01-PL	95B010040
			M8 connector	S3Z-PR-5-C01-PL	95B010050
		PNP - DARK	2 m cable	S3Z-PR-2-C01-PD	95B010060
			M8 connector	S3Z-PR-5-C01-PD	95B010070
		NPN - LIGHT	2 m cable	S3Z-PR-2-C01-NL	95B010200
			M8 connector	S3Z-PR-5-C01-NL	95B010210
		NPN - DARK	2 m cable	S3Z-PR-2-C01-ND	95B010220
			M8 connector	S3Z-PR-5-C01-ND	95B010230
Background suppression	50...300 mm	PNP - LIGHT	2 m cable	S3Z-PR-2-M01-PL	95B010330
			M8 connector	S3Z-PR-5-M01-PL	95B010350
		NPN - LIGHT	2 m cable	S3Z-PR-2-M01-NL	95B010320
			M8 connector	S3Z-PR-5-M01-NL	95B010340

INFRARED LED MODELS					
OPTIC FUNCTION	OPERATING DISTANCE	OUTPUT	CONNECTION	MODEL	ORDER No.
Long diffuse proximity	0... 700 mm	PNP - LIGHT	2 m cable	S3Z-PR-2-C11-PL	95B010001
			M8 connector	S3Z-PR-5-C11-PL	95B010011
		PNP - DARK	2 m cable	S3Z-PR-2-C11-PD	95B010021
			M8 connector	S3Z-PR-5-C11-PD	95B010031
		NPN - LIGHT	2 m cable	S3Z-PR-2-C11-NL	95B010161
			M8 connector	S3Z-PR-5-C11-NL	95B010171
		NPN - DARK	2 m cable	S3Z-PR-2-C11-ND	95B010181
			M8 connector	S3Z-PR-5-C11-ND	95B010191
Through beam (emitter & receiver unit)	0...20 m	PNP - LIGHT	2 m cable	S3Z-PR-2-FG01-PL	95B010121
			M8 connector	S3Z-PR-5-FG01-PL	95B010131
		PNP - DARK	2 m cable	S3Z-PR-2-FG01-PD	95B010141
			M8 connector	S3Z-PR-5-FG01-PD	95B010151
		NPN - LIGHT	2 m cable	S3Z-PR-2-FG01-NL	95B010281
			M8 connector	S3Z-PR-5-FG01-NL	95B010291
		NPN - DARK	2 m cable	S3Z-PR-2-FG01-ND	95B010301
			M8 connector	S3Z-PR-5-FG01-ND	95B010311

LIGHT= N.O.  
DARK= N.C.

## DIAGRAM LED MODELS

BACKGROUND SUPPRESSION - DISTANCE DIFFERENCE VS REFLECTANCE TARGET

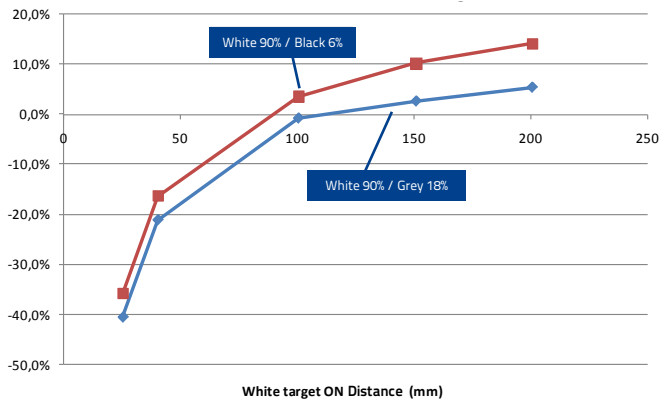

THROUGH BEAM - DETECTION AREA

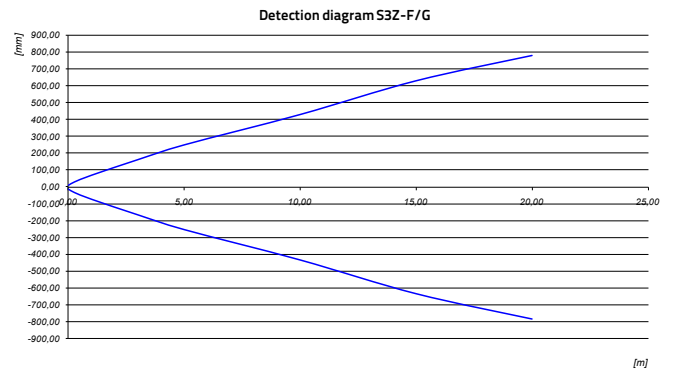

POLARIZED RETROREFLECTIVE - DETECTION AREA

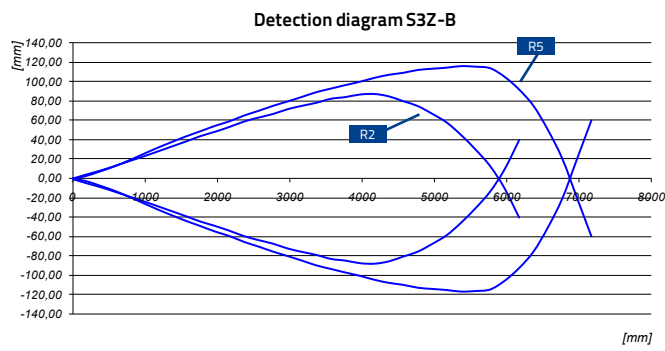

DIFFUSE PROXIMITY - DETECTION AREA

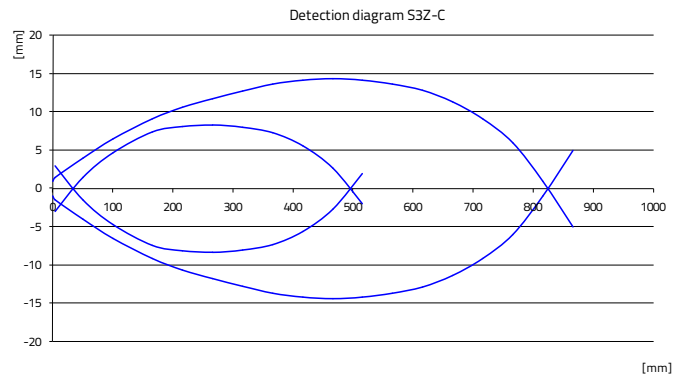

NARROW BEAM PROXIMITY - DETECTION AREA

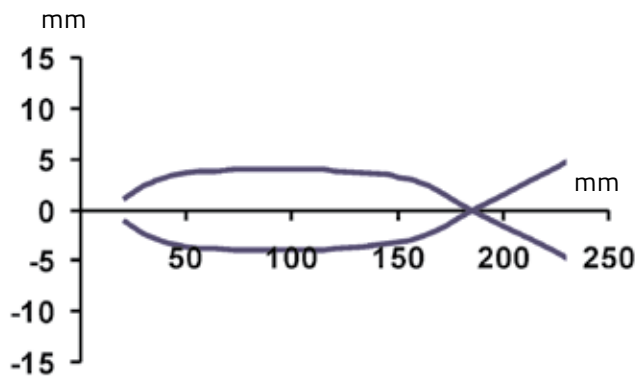

POLARIZED RETROREFLECTIVE FOR TRANSPARENT - DETECTION AREA

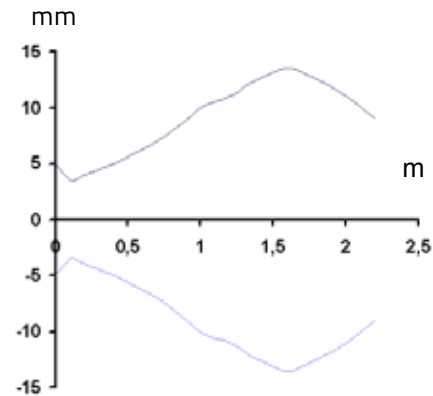

RED LASER MODELS					
RED LASER: Class 1 EN 60825-1 (2007) (mod.B01/C01/G00) Class II CDRH 21 CFR PART 1040.10 (mod.B01/C01/G00) Max. power ≤ 7 mW; λ = 650 nm					
OPTIC FUNCTION	OPERATING DISTANCE	CONNECTION	OUTPUT	MODEL	ORDER No.
Polarized retroreflective	0,3...10 m (on R2) (spot: Ø 5mm @ 3m)	PNP - DARK/LIGHT	2 m cable	S3Z-PH-2-B01-PP	95B010440
			M8 connector	S3Z-PH-5-B01-PP	95B010460
		NPN - DARK/LIGHT	2 m cable	S3Z-PH-2-B01-NN	95B010450
			M8 connector	S3Z-PH-5-B01-NN	95B010470
Through beam	0...30 m (spot: Ø 5mm @ 3m)	PNP - DARK/LIGHT	2 m cable	S3Z-PH-2-FG01-PP	95B010520
			M8 connector	S3Z-PH-5-FG01-PP	95B010540
		NPN - DARK/LIGHT	2 m cable	S3Z-PH-2-FG01-NN	95B010530
			M8 connector	S3Z-PH-5-FG01-NN	95B010550
Background suppression	40...300 mm, ΔGrey/White: 10% (spot: Ø 0,5mm @ 170 mm)	PNP - DARK/LIGHT	2 m cable	S3Z-PH-2-M01-PP	95B010480
			M8 connector	S3Z-PH-5-M01-PP	95B010500
		NPN - DARK/LIGHT	2 m cable	S3Z-PH-2-M01-NN	95B010490
			M8 connector	S3Z-PH-5-M01-NN	95B010510

LIGHT= N.O.  
DARK= N.C.

## DIAGRAMS LASER MODELS

### BACKGROUND SUPPRESSION - DETECTION AREA

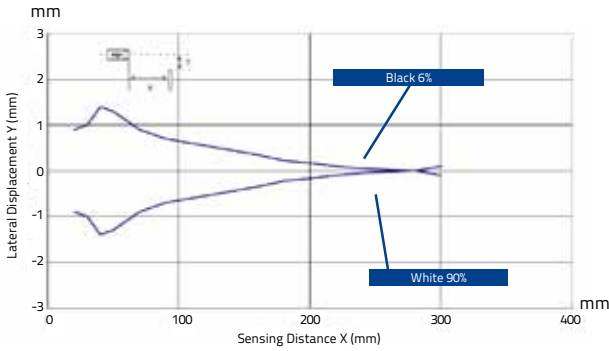

### BACKGROUND SUPPRESSION - SPOT DIMENSION

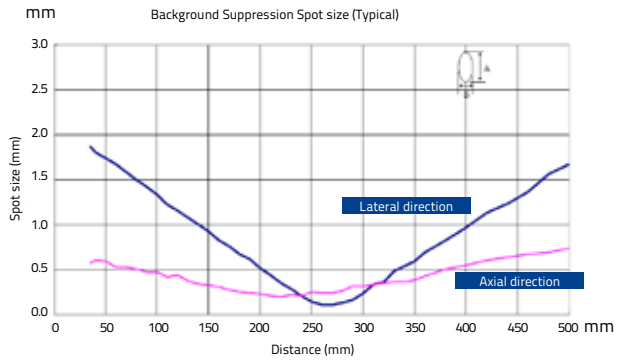

### POLARIZED RETROREFLECTIVE - DETECTION AREA

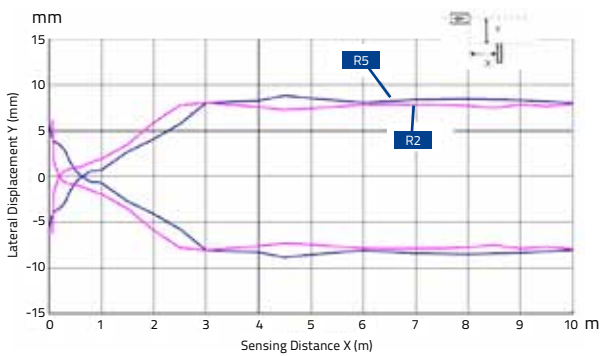

### POLARIZED RETROREFLECTIVE - EXCESS GAIN

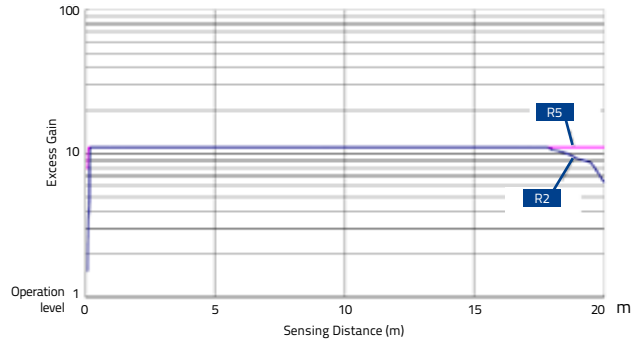

### THROUGH BEAM - DETECTION AREA

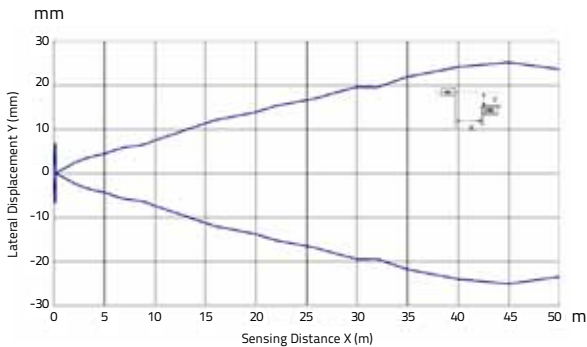

### THROUGH BEAM - EXCESS GAIN

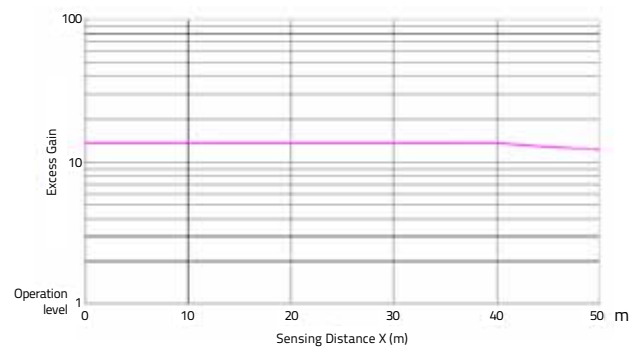

## ACCESSORY SELECTION TABLE

MODEL	DESCRIPTION	ORDER NO.
ST-5039	L-shaped fixing bracket	95ACC2270
ST-5040	protection bracket with vertical fixing (only for cable versions)	95ACC2280
ST-5046	protection bracket with horizontal fixing	95ACC2370
S3Z-SLIT1	Ø 0,5 mm slit for through beam	95ACC2470
S3Z-SLIT2	Ø 1 mm slit for through beam	95ACC2480
S3Z-SLIT3	Ø 2 mm slit for through beam	95ACC2490
S3Z-SLIT4	0,5x18 mm slit for through beam	95ACC2500
S3Z-SLIT5	1x18 mm slit for through beam	95ACC2510
S3Z-SLIT6	2x18 mm slit for through beam	95ACC2520
ST-S3Z-M18	S3Z FIX BRK M18 THREADED NOSE	95ACC7850

## ACCESSORY

ST-5039

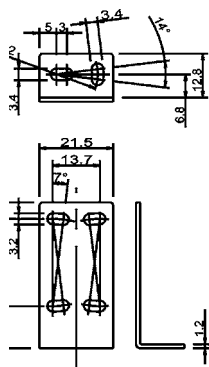

ST-5046

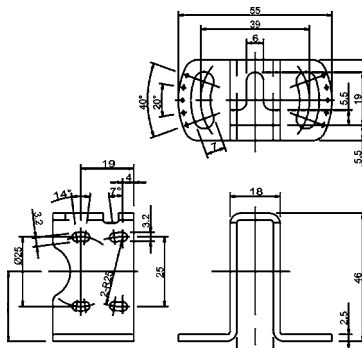

ST-5040

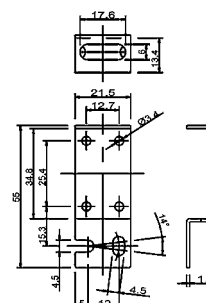

## SLIT

Two different slit models, with rectangular or circular slot, can be easily mounted on the front side of the through beam sensors to reduce the emission beam. The resolution and the minimum object detectable can be improved with the slit positioned on the receiver (S3Z...F01).

The installation of the two aligned sensor couples is eased by mounting the slit also on the emitter (S3Z...G00), avoiding reciprocal interference. The slit reduces the operating distance as shown in the following table.

Slit Model	Width (mm)	Operating distance		Minimum object detectable (mm)	
		Used on F01	Used on F01 and G00	Used on F01	Used on F01 and G00
S3Z-SLIT1	Ø 0.5	0.8	0.08	5	0.3
S3Z-SLIT2	Ø 1	1.5	0.3	5	0.6
S3Z-SLIT3	Ø 2	2.5	1.2	5	1.5
S3Z-SLIT4	0.5x18	2.5	1	7	0.5
S3Z-SLIT5	1x18	3.5	1.5	7	1
S3Z-SLIT6	2x18	6	3.5	7	2

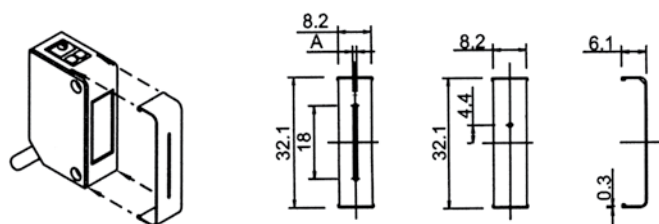

## M18 NOSE

The patented ST-S3Z-M18 accessory allows to adapt the miniature sensor S3Z to a M18 tubular mounting. It can be principally use with through beam and retroreflective models fixing the sensor in the proper holes as indicated on the housing.

The accessory affects the optic system narrowing the detection beam without changing the operating distance.



Rev. 00, 11/2013

